

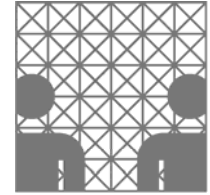

Universität Hamburg

Seminar WS 08/09
Surface Reconstruction
Dr. Peer Stellingner



Surface Reconstruction

Digitalisierung

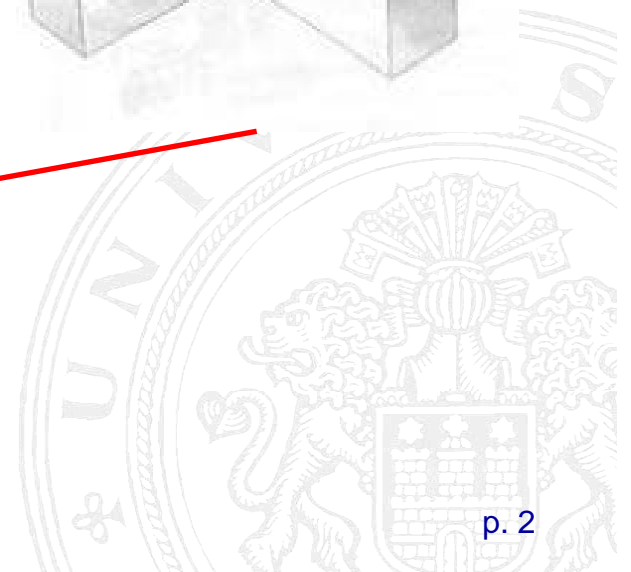
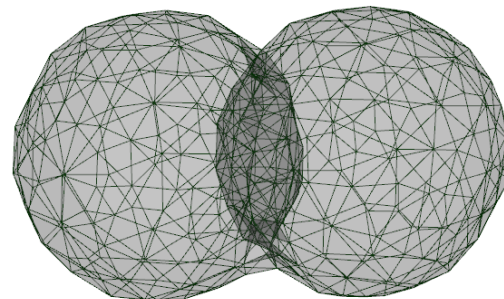
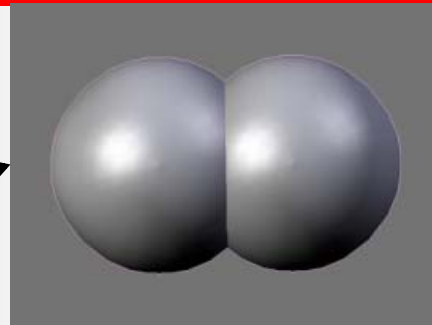
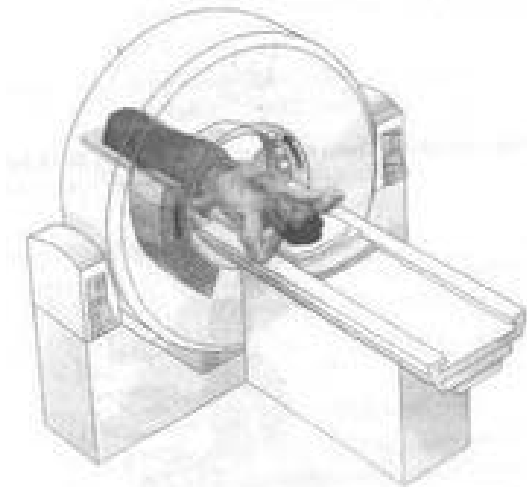
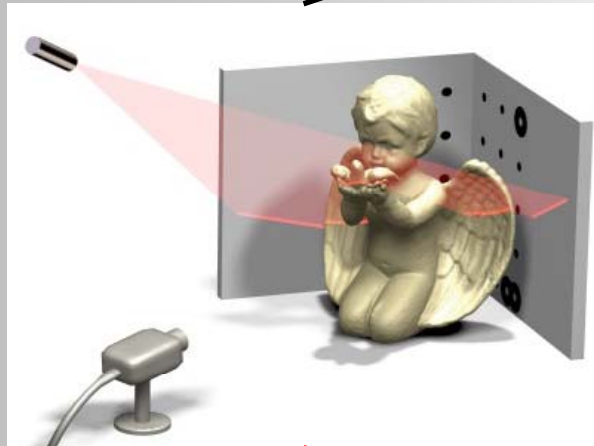
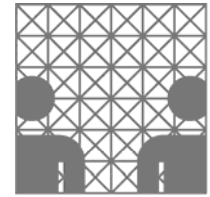

Digitalisierung

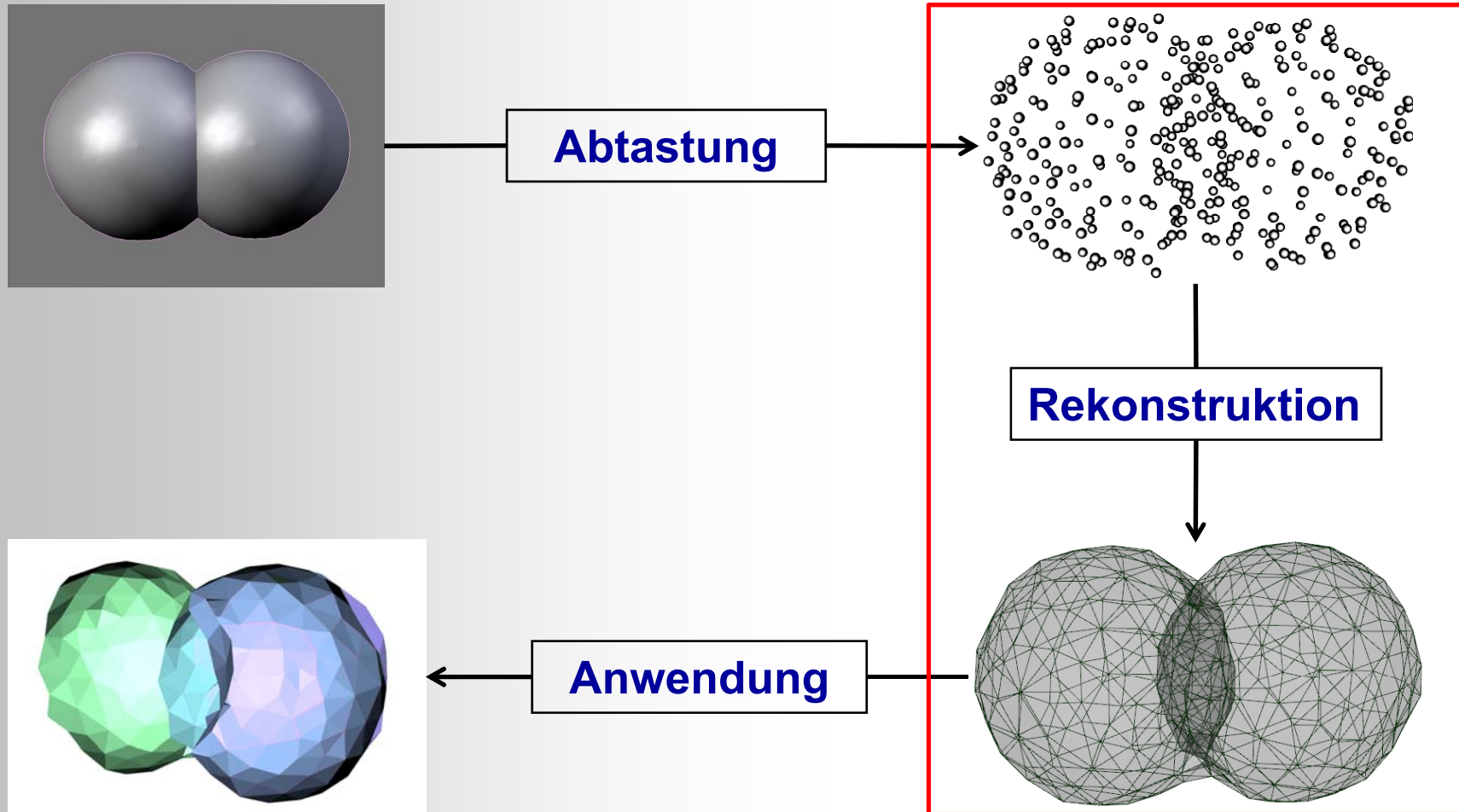
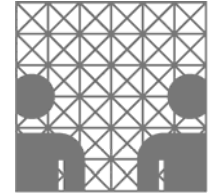

Rekonstruktion

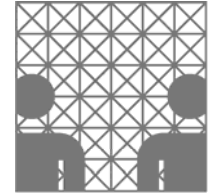

Bedienungen an die Abtastung

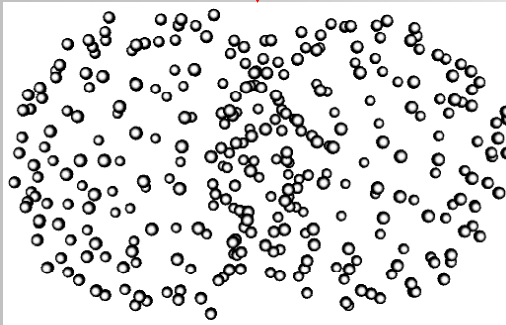

Beweisverfahren

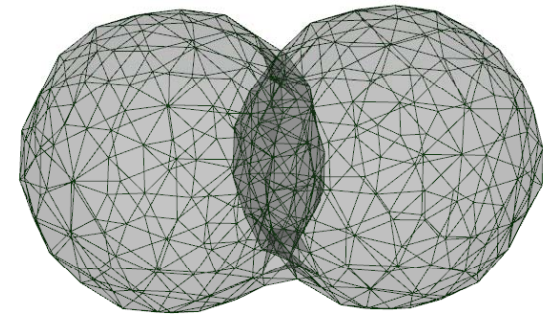

Methode

Surface Reconstruction

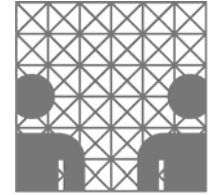

- **Computational Geometry**

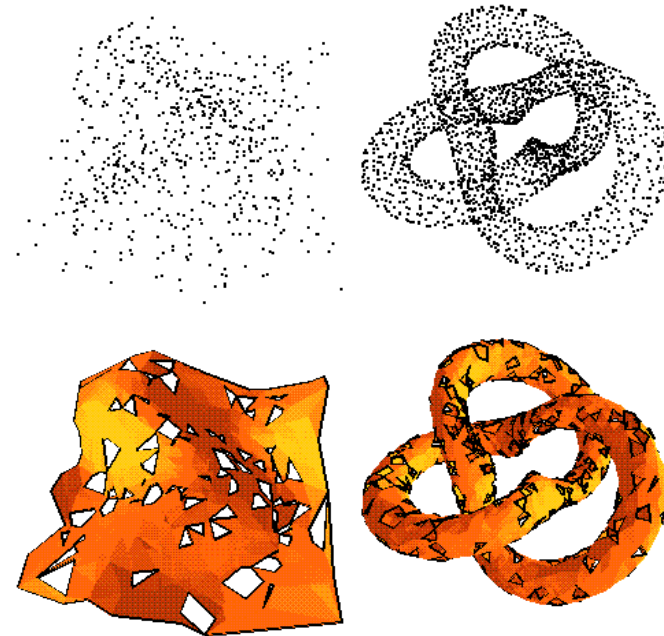

Surface Reconstruction

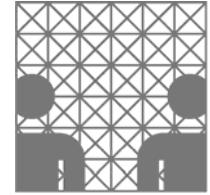

- Computational Geometry
- Surface Fitting

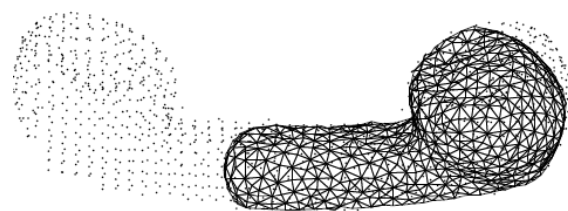
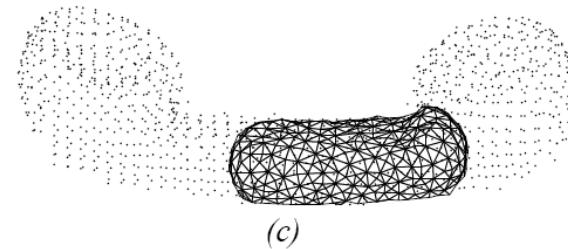
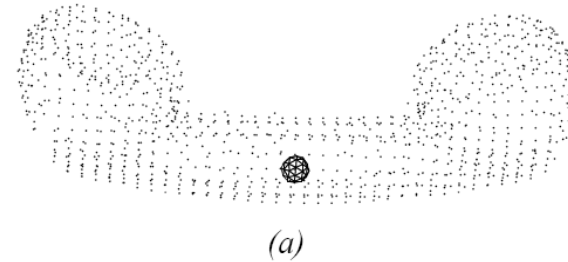

Surface Reconstruction

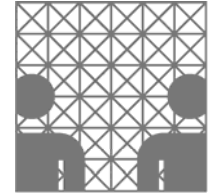

- **Computational Geometry**
- **Surface Fitting**
- **Implicit Function Fitting**

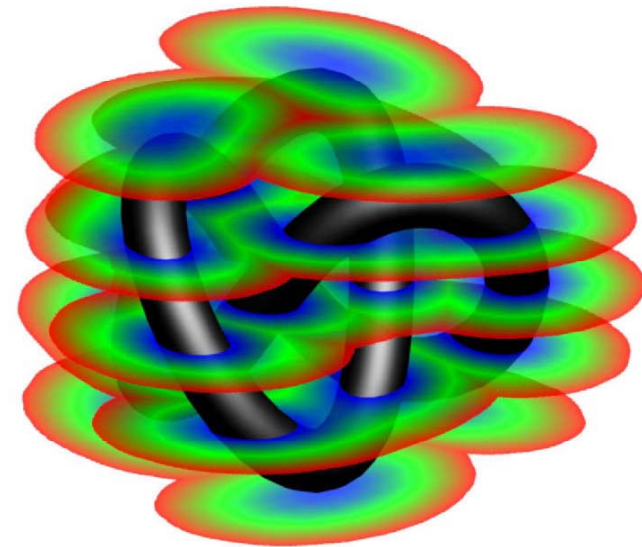

Computational Geometry

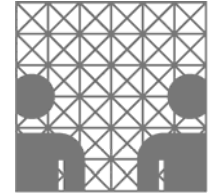

- **Voronoi Diagrams, Delaunay Triangulations and Alpha Shapes**

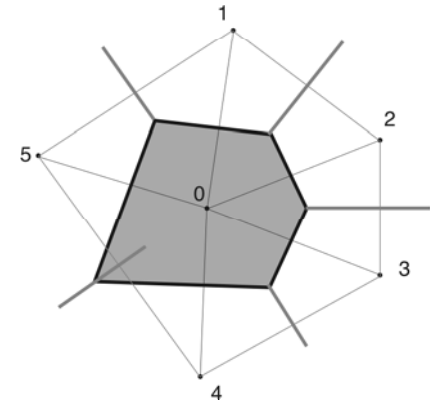

Computational Geometry

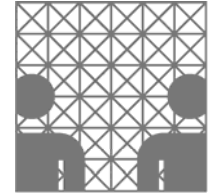

- Voronoi Diagrams, Delaunay Triangulations and Alpha Shapes
- Flow Shapes

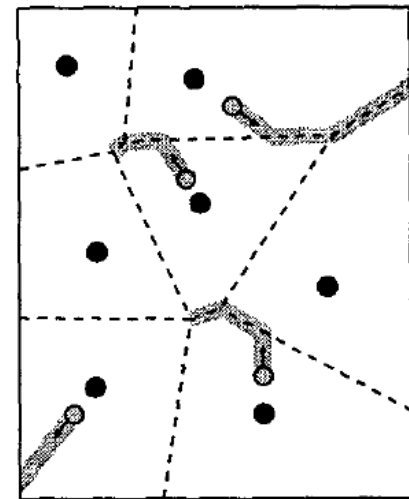

Computational Geometry

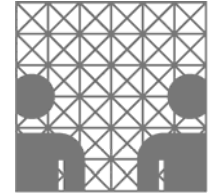

- Voronoi Diagrams, Delaunay Triangulations and Alpha Shapes
- Flow Shapes
- r -Regular Shape Reconstruction

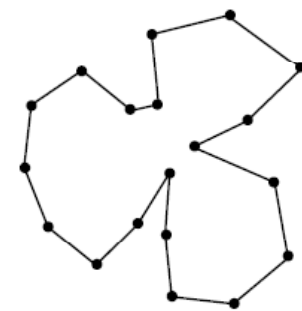
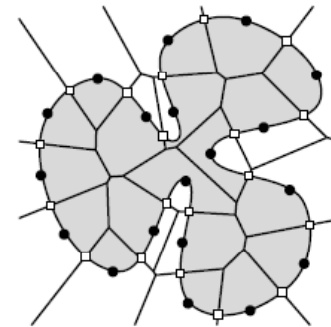
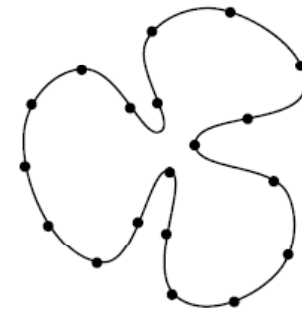

Computational Geometry

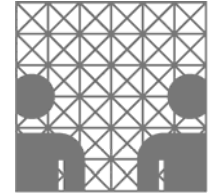

- **Voronoi Diagrams, Delaunay Triangulations and Alpha Shapes**
- **Flow Shapes**
- **r-Regular Shape Reconstruction**
- **One Triangle at a Time**

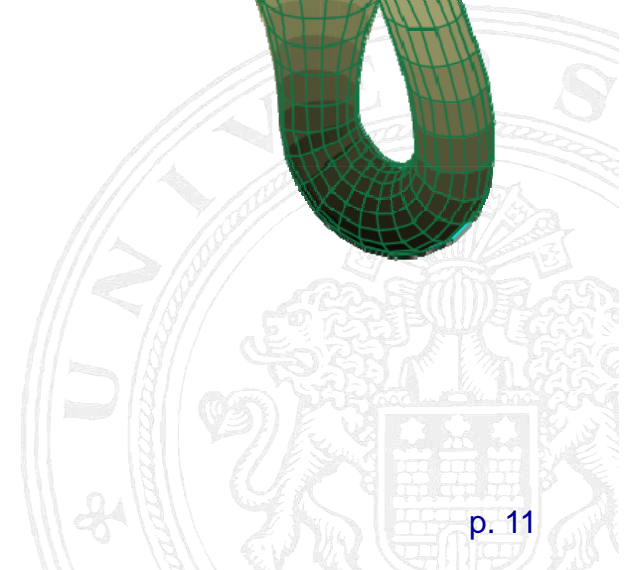
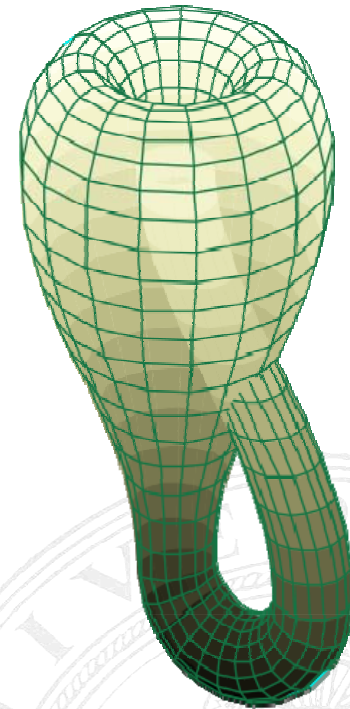

Computational Geometry

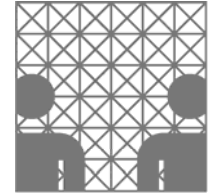

- Voronoi Diagrams, Delaunay Triangulations and Alpha Shapes
- Flow Shapes
- r -Regular Shape Reconstruction
- One Triangle at a Time
- Lower Dimensional Localized Delaunay Triangulation

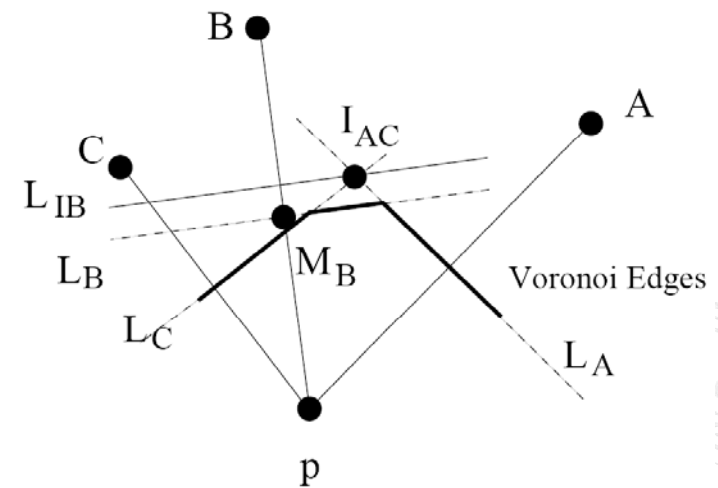

Computational Geometry

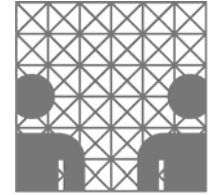

- Voronoi Diagrams, Delaunay Triangulations and Alpha Shapes
- Flow Shapes
- r -Regular Shape Reconstruction
- One Triangle at a Time
- Lower Dimensional Localized Delaunay Triangulation
- Ball Pivoting

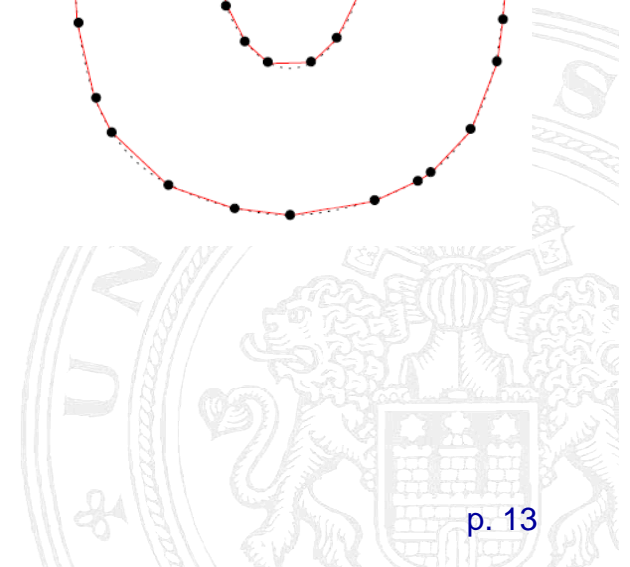
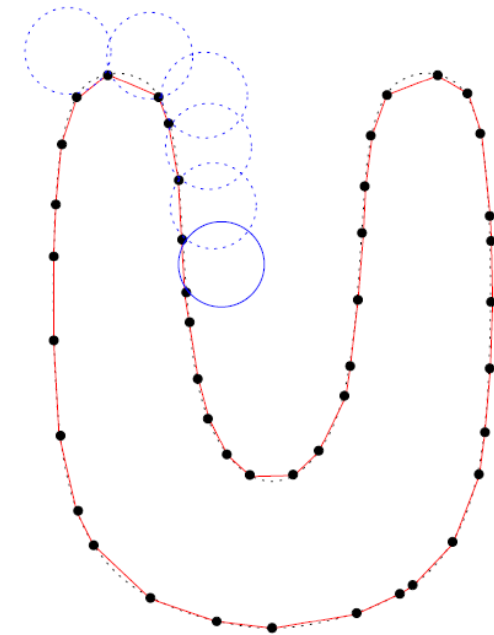

Computational Geometry

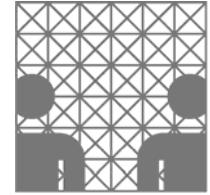

- **Voronoi Diagrams, Delaunay Triangulations and Alpha Shapes**
- **Flow Shapes**
- **r-Regular Shape Reconstruction**
- **One Triangle at a Time**
- **Lower Dimensional Localized Delaunay Triangulation**
- **Ball Pivoting**
- **Crust**

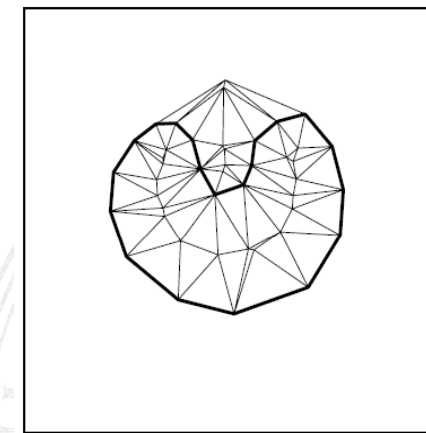
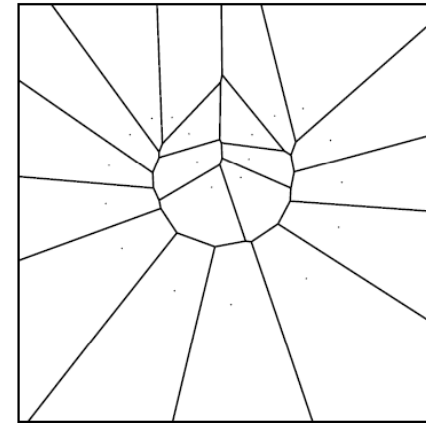

Computational Geometry

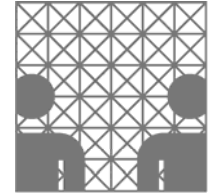

- **Voronoi Diagrams, Delaunay Triangulations and Alpha Shapes**
- **Flow Shapes**
- **r-Regular Shape Reconstruction**
- **One Triangle at a Time**
- **Lower Dimensional Localized Delaunay Triangulation**
- **Ball Pivoting**
- **Crust**
- **Power Crust**

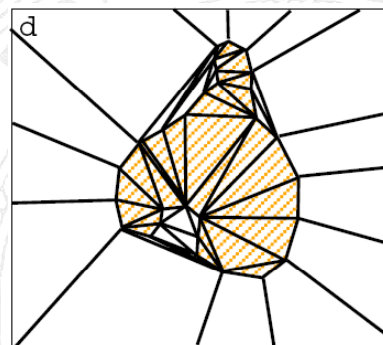
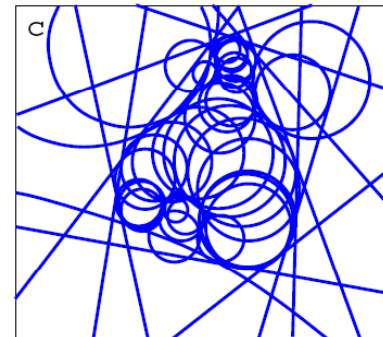
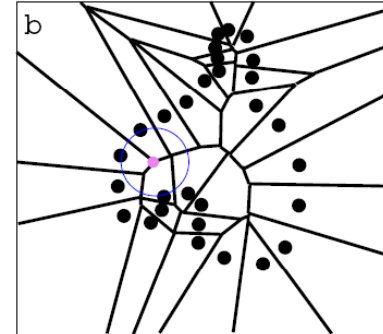

Computational Geometry

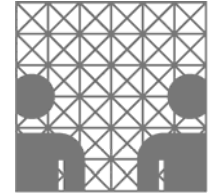

- Voronoi Diagrams, Delaunay Triangulations and Alpha Shapes
- Flow Shapes
- r -Regular Shape Reconstruction
- One Triangle at a Time
- Lower Dimensional Localized Delaunay Triangulation
- Ball Pivoting
- Crust
- Power Crust
- Cocone

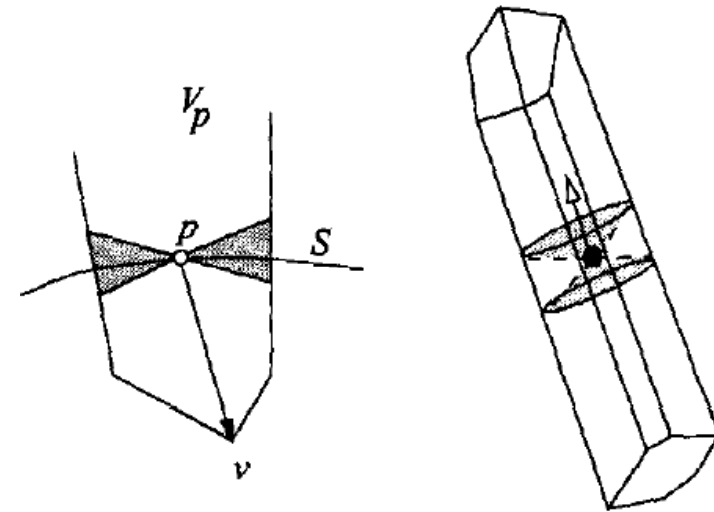

Computational Geometry

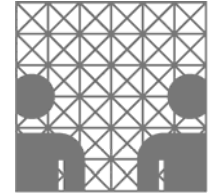

- **Voronoi Diagrams, Delaunay Triangulations and Alpha Shapes**
- **Flow Shapes**
- **r-Regular Shape Reconstruction**
- **One Triangle at a Time**
- **Lower Dimensional Localized Delaunay Triangulation**
- **Ball Pivoting**
- **Crust**
- **Power Crust**
- **Cocone**
- **Homology of Submanifolds**



Computational Geometry

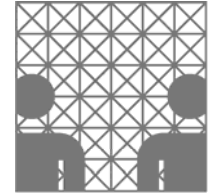

- Voronoi Diagrams, Delaunay Triangulations and Alpha Shapes
- Flow Shapes
- r -Regular Shape Reconstruction
- One Triangle at a Time
- Lower Dimensional Localized Delaunay Triangulation
- Ball Pivoting
- Crust
- Power Crust
- Cocone
- Homology of Submanifolds
- Lipschitz Surfaces

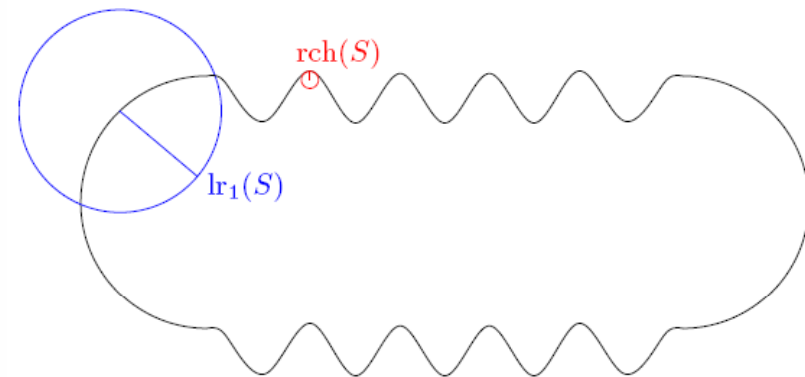
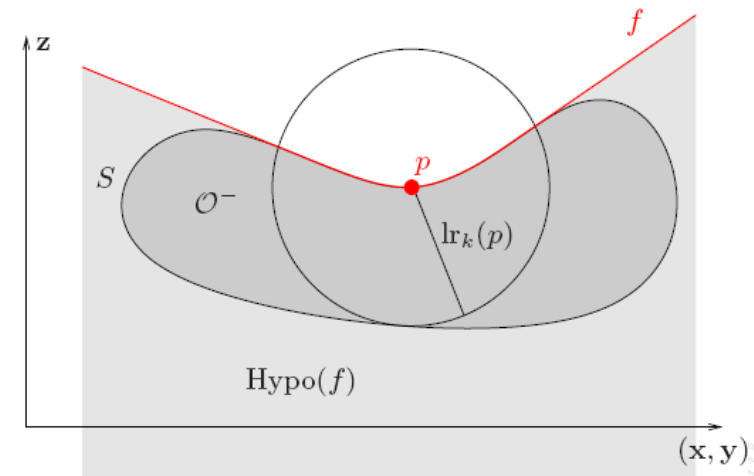

Computational Geometry

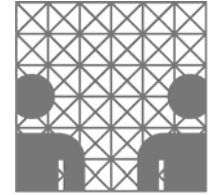

- Voronoi Diagrams, Delaunay Triangulations and Alpha Shapes
- Flow Shapes
- r-Regular Shape Reconstruction
- One Triangle at a Time
- Lower Dimensional Localized Delaunay Triangulation
- Ball Pivoting
- Crust
- Power Crust
- Cocone
- Homology of Submanifolds
- Lipschitz Surfaces
- r-Stable Reconstruction

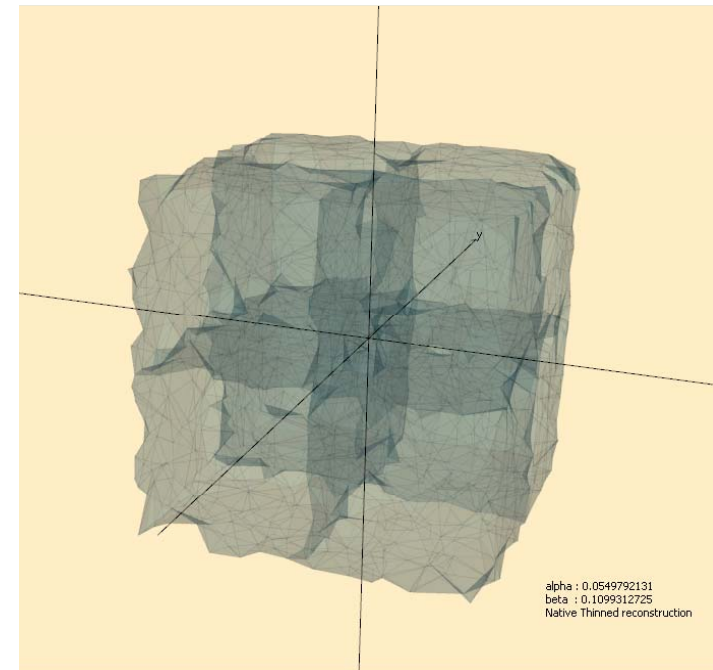

Surface Fitting

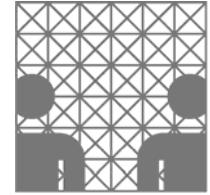

- **Adaptive Meshes**

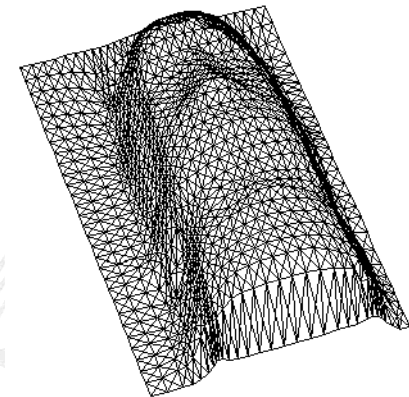
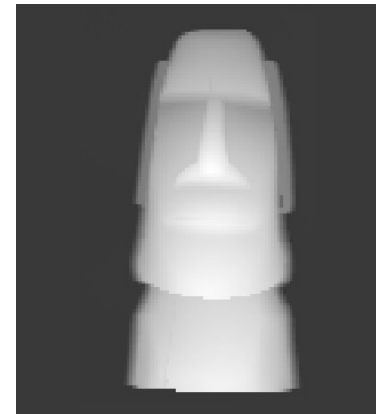

Surface Fitting

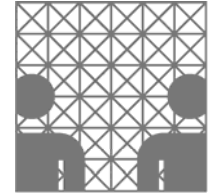

- Adaptive Meshes
- Balloon Fitting

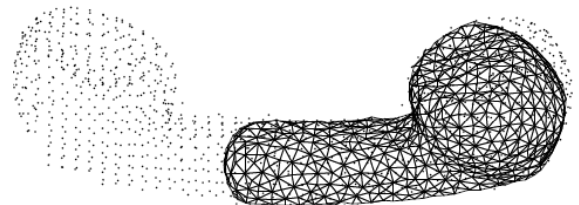
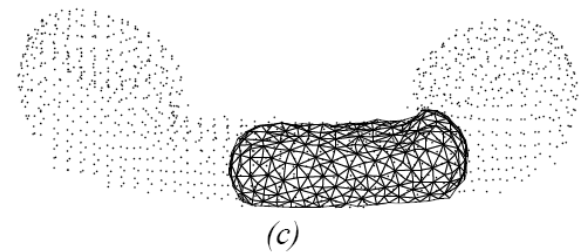
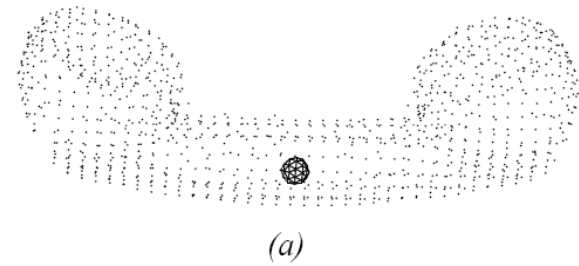

Surface Fitting

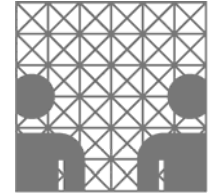

- **Adaptive Meshes**
- **Balloon Fitting**
- **Surface Inferencing**

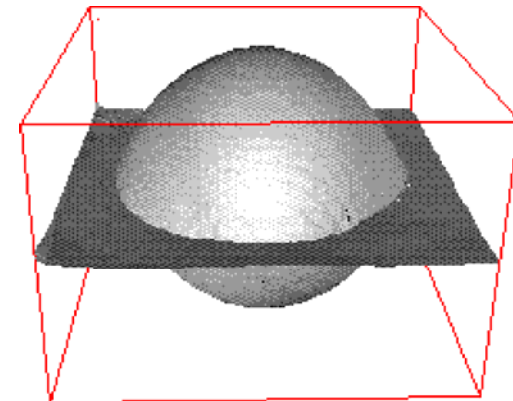
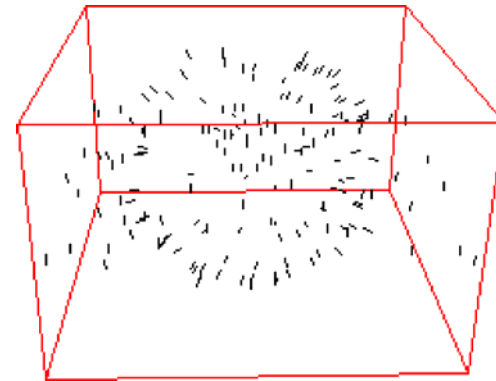

Surface Fitting

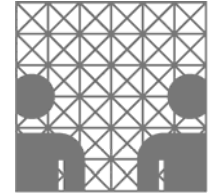

- Adaptive Meshes
- Balloon Fitting
- Surface Inferencing
- Moving Least Squares

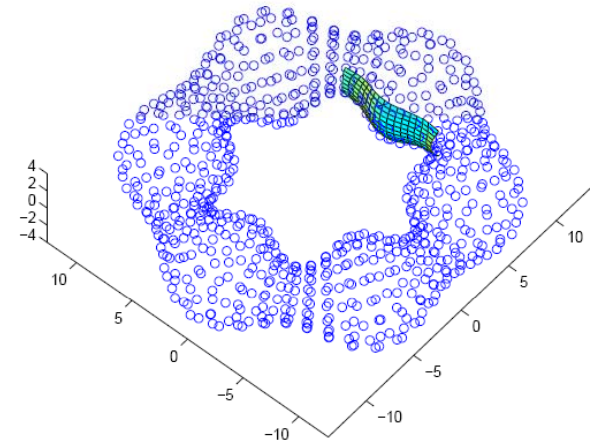
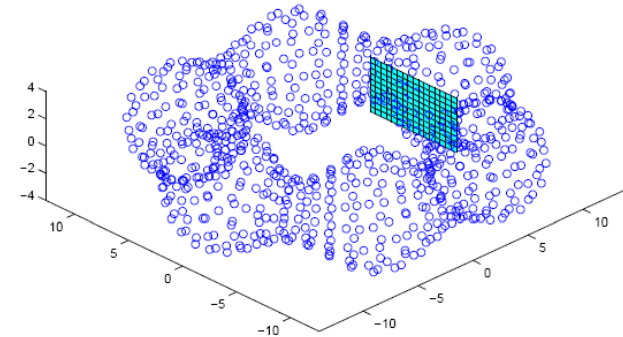

Implicit Function Fitting

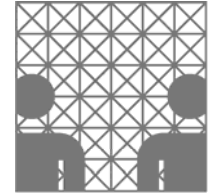

- Surfaces from Unorganized Points

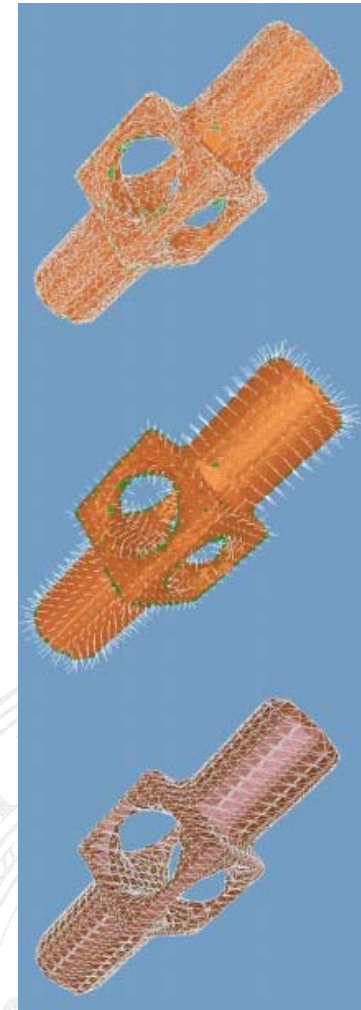

Implicit Function Fitting

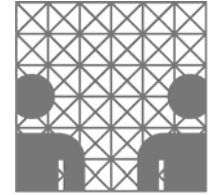

- Surfaces from Unorganized Points
- Radial Basis Functions



Implicit Function Fitting

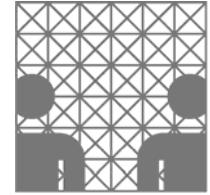

- Surfaces from Unorganized Points
- Radial Basis Functions
- Level Sets

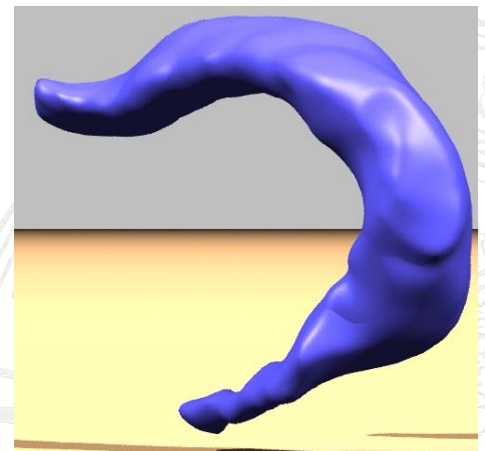
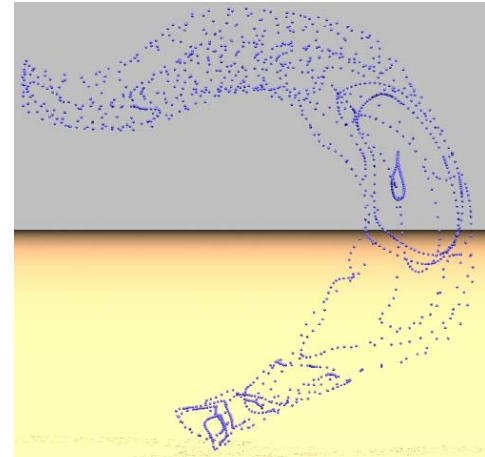

Implicit Function Fitting

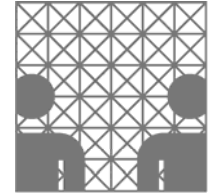

- Surfaces from Unorganized Points
- Radial Basis Functions
- Level Sets
- FFT-Based Reconstruction

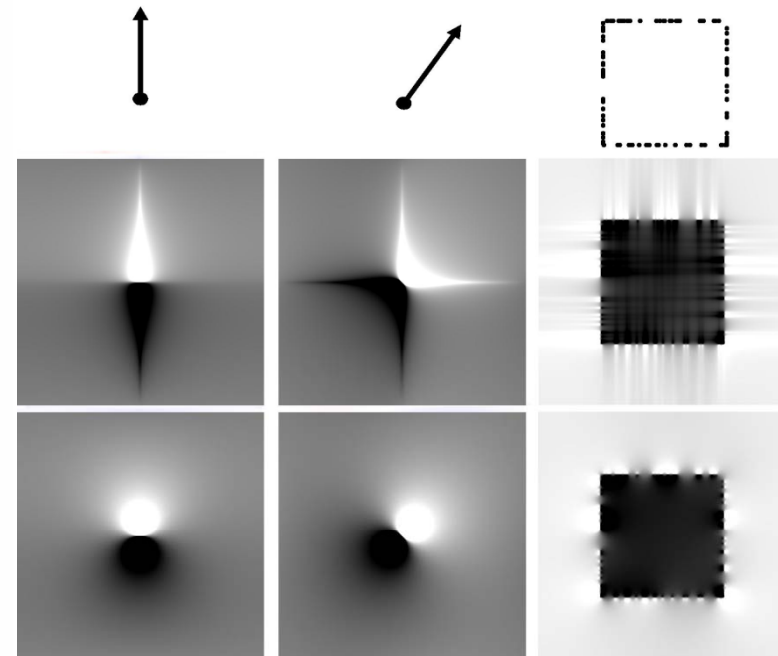

References

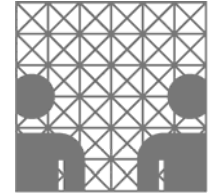

- **Voronoi Diagrams, Delaunay Triangulations and Alpha Shapes**
 - “The Union of Balls and Its Dual Shape*”, 1995, H. Edelsbrunner
 - “Three-Dimensional Alpha Shapes”, 1995, H. Edelsbrunner, E.P. Mücke
 - “Introduction to Alpha Shape”, 2000, K. Fisher
- **Flow Shapes**
 - „The Flow Complex: A Data Structure for Geometric Modeling“, 2003, J. Giesen, M. John
 - “Alpha-Shapes and Flow Shapes are Homotopy Equivalent”, 2003, T.K. Dey, J. Giesen, M. John
- **r-Regular Shape Reconstruction**
 - „r-Regular Shape Reconstruction from Unorganized Points“, 1997, D. Attali
- **One Triangle at a Time**
 - “Surface Reconstruction, One Triangle at a Time”, 2004, D. Freedman
- **Lower Dimensional Localized Delaunay Triangulation**
 - “Surface Reconstruction based on Lower Dimensional Localized Delaunay Triangulation”, 2000, M. Gopi, S. Krishnan, C.T. Silva
- **Ball Pivoting**
 - „The Ball-Pivoting Algorithm for Surface Reconstruction“, 1997, F. Bernardini, J. Mittleman, H. Rushmeier, C. Silva, G. Taubin
- **Crust**
 - „the Crust and the β -Skeleton: Combinatorial Curve Reconstruction“, 1998, N. Amenta, M. Bern, D. Eppstein
 - „A New Voronoi-Based Surface Reconstruction Algorithm“, 1998, N. Amenta, M. Bern, M. Kamvysselis

References

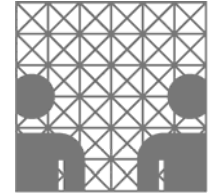

- **Power Crust**
 - „The Power Crust“, 2001, N. Amenta, S. Choi, R.K. Kolluri
 - „The Power Crust, Union of Balls, and the Medial Axis Transform“, 2001, N. Amenta, S. Choi, R.K. Kolluri
- **Cocone**
 - „A Simple Algorithm for Homeomorphic Surface Reconstruction“, 2001, N. Amenta, S. Choi, T.K. Dey, N. Leekha
 - „Tight Cocone : A Watertight Surface Reconstructor“, 2003, T.K. Dey, S. Goswami
- **Homology of Submanifolds**
 - “Finding the Homology of Submanifolds with High Confidence from Random Samples”, 2004, P. Niyogi, S. Smale, S. Weinberger
- **Lipschitz Surfaces**
 - “Provably Good Sampling and Meshing of Lipschitz Surfaces”, 2006, J-D. Boissonnat, S. Oudot
 - “Guaranteed-Quality Mesh Generation for Curved Surfaces”, 1993, L.P. Chew
- **r-Stable Reconstruction**
 - “Topologically Correct 3D Surface Reconstruction and Segmentation from Noisy Samples”, 2008, P. Stelldinger

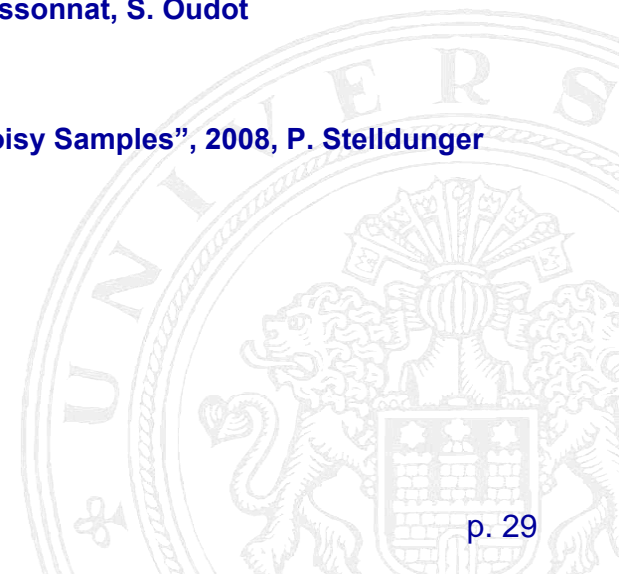

References

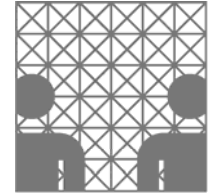

- **Adaptive Meshes**
 - “Sampling and Reconstruction with Adaptive Meshes”, 1991, D. Terzopoulos, M. Vasilescu
- **Balloon Fitting**
 - „Description of Complex Objects from Multiple Range Images Using an Inflating Balloon Model“, 1995, Y. Chen, G. Medioni
- **Surface Inferencing**
 - „Inference of Surfaces, 3D Curves, and Junctions From Sparse, Noisy, 3D Data“, 1997, G. Guy, G. Medioni
 - „Inference of Integrated Surface, Curve, and Junction Descriptions, From Sparse 3D Data“, 1998
- **Moving Least Squares**
 - „Drawing Contours from Arbitrary Data Points“, 1974 D.H. McLain
 - „Mesh-Independent Surface Interpolation“, 2003, D. Levin
- **Surfaces from Unorganized Points**
 - „Surface Reconstruction from Unorganized Points“, 1992, H. Hoppe, T. DeRose, T. Duchamp
- **Radial Basis Functions**
 - „Reconstruction and Representation of 3D Objects with Radial Basis Functions“, 2001, J.C. Carr, R.K. Beatson, J.B. Cherrie, T.J. Mitchel, W.R. Fright, B.C. McCallum, T.R. Evans
- **Level Sets**
 - „Fast Surface Reconstruction Using the Level Set Method“, 2001, H.K. Zhao, S. Osher, R. Fedkiw
 - „Visualization, Analysis and Shape Reconstruction of Unorganized Data Sets“, 2002, H.K. Zhao, S. Osher
- **FFT-Based Reconstruction**
 - „Reconstruction of Solid Models from Oriented Point Sets“, 2005, M. Kazhdan